



MAKES IT HAPPEN

▶ Multi-talents up to 3.5 t

Tipper & Transporters

Rear and three-way tippers / plant transporters



HUMBAUR
CAR TRAILERS



3000/3500 Series

humbaur.com

I'm a true follower!

Because a HUMBAUR is as weather-resistant as I am.

Oliver Wiesinger, landscape gardener

▶ 30 years of experience

We have been one of the leading manufacturers of passenger vehicle trailers for three decades. Over 750,000 trailers have left our premises since our company was founded. Nowadays, we produce around 50,000 units per year. And our wealth of experience is reflected in each of our trailers.

▶ High quality

Robust and long-lasting – that's what a trailer needs to be.

We use outstanding components and first-rate processing to achieve this goal. Before we deliver each trailer, we put it through its paces.

▶ A wide range of transportation solutions

Our offering covers a very wide range of applications: Whether you are looking for a trailer in a private or commercial capacity: With us you will find the appropriate model for a wide variety of applications.

You can choose between a total permissible weight from 750 kg up to 50 t.



Table of contents

Good reasons 2
 Overview of rear and three-way tippers..... 4

▶ Rear tippers

HUK single-axle/tandem-axle..... 6

▶ Three-way tippers

HTK single/tandem and three-axle..... 10

▶ Plant transporters

HS tandem-axle 16
 HS tandem-axle Profi 20

Optional accessories..... 20

About Humbaer 22

▶ Wide range of accessories

Do you have very specific demands of your trailer? Thanks to a number of matching accessories, you can add to the comprehensive standard features to meet your requirements accordingly.

▶ Committed customer service

If your trailer weighs up to 3.5 t, your specialist dealer in your area will be happy to help. Owners of trailers weighing upwards of 5 t total weight are able to take advantage of our direct service. Whether you need a spare part or have a question about how to use your trailer – we, together with your on-site dealer, will be happy to help.

▶ High-quality components

Quality is reflected in the detail – that’s why Humbaer only uses high-quality vehicle components that have been produced by reputable manufacturers. We continuously share our experiences with our suppliers. In this way we are able to continuously improve our products.

Rear or three-way tippers and plant transporters – the specialists for multiple tasks

The 3000 Series



▶ Rear tipper HUK

The new single and tandem-axle models. Standard features of the HUK models include welded and hot-dip galvanised frame parts, integrated tie-down hoops, a steel tipping platform and a three-stage tilt cylinder operated by hand pump.

FROM PAGE 6



▶ Three-way tipper HTK Alu

Our HTK shines with its quality and a hand pump that can be replaced by an electric hydraulic pump if required. From 3000 kg you will receive the electric and hand pump as standard. So you can use your HTK for every application easily and independently. The HTK is available as a single, tandem and a three-axle version.

FROM PAGE 10



▶ Construction machine transporter HS

Do you regularly have to transport light or medium-duty plant or diggers? The HS is designed for daily transportation with its solid construction. The low loading height facilitates loading. The accessible wings and protected lighting units make it particularly suitable for everyday use.

FROM PAGE 16



► **Construction machine transporter HS**

The HS Profi is the payload-optimised plant transporter. It takes up to 2800 kg payload with aluminium drive-up ramps with built-in support, a wooden floor and an approx. 200 mm high circumferential railing that is welded to the frame. Six lashing points welded in the frame allow the load to be secured

FROM PAGE 20



Rear tipper **HUK**

The new HUK as single and tandem axle models



▶ Standard equipment



- 1 Chassis and tilt bridge welded and hot-dip galvanised
- 2 Galvanised bridge floor
- 3 300 mm side plates hinged all round
- 4 Hand pump, optional electric hydraulic pump
- 5 Drawbar closures
- 6 Conical end stanchions, removable
- 7 3-stage telescopic cylinder with hand pump
- 8 V-groove outer frame with recessed tie-down hoops
- 9 Lighting integrated in the rear underride protection
- 10 Automatic jockey wheel





3000 Series

Rear tipper HUK

Permissible gross weight in kg	MODEL	Overall dimension in mm	Internal dimensions in mm	Load capacity in kg	Load height in mm	Tyres in inches	Tilt angle (rear)
1300	HUK 132314	3650 x 1540 x 950	2300 x 1400 x 300	900	640	13	45°
1,500	HUK 152314	3650 x 1540 x 950	2300 x 1400 x 300	1100	640	13	45°
1,500	HUK 152715	4130 x 1640 x 980	2680 x 1500 x 300	1025	670	13	45°
1,800	HUK 182715	4130 x 1640 x 980	2680 x 1500 x 300	1310	670	13	45°
2,000	HUK 202715	4130 x 1640 x 980	2680 x 1500 x 300	1470	680	13	45°
2,700	HUK 272715	4130 x 1640 x 980	2680 x 1500 x 300	2160	680	13	45°
2,700	HUK 273117	4510 x 1890 x 970	3140 x 1750 x 300	2010	670	13	45°
3,000	HUK 303117	4510 x 1890 x 970	3140 x 1750 x 300	2,310	670	13	45°



► **Accessories (available as an option)**

- 350 mm side plate extension
- Closed aluminium extension 620 mm
- Steel lattice extension 620 mm
- E-pump
- Tarpaulin & frame, various load heights
- Supporting feet
- Toolbox

Additional accessories available on request



- 1 Double acting hand pump fitted as standard
- 2 Drawbar closures for the side plates
- 3 Steel lattice extension (optional)

Single and tandem-axle HTK

Robust, flexible and a great transporter!



► **Standard equipment**

- 1** Squarotow bar bolted with welded frame construction, hot-dip galvanised
- 2** Chassis and tilt bridge hot-dip galvanised
- 3** Tilt bridge made of steel, manufactured from one piece
- 4** 4-stage tilt cylinder
- 5** Hand pump, optional electric hydraulic pump; from 3000 kg permissible total weight electric and hand pump
- 6** Humbaar multifunctional lighting
- 7** 13-pin plug and reversing light
- 8** Side plates made from anodised aluminium, can be fully removed
- 9** Rear panel can be pivoted
- 10** Tie rings integrated in the bridge floor, tensile force 800 kg per tie ring
- 11** Automatic jockey wheel
- 12** Standard panel bay integrated in the vehicle for easy retrofitting of the aluminium panels

Side panels
optionally
in steel!



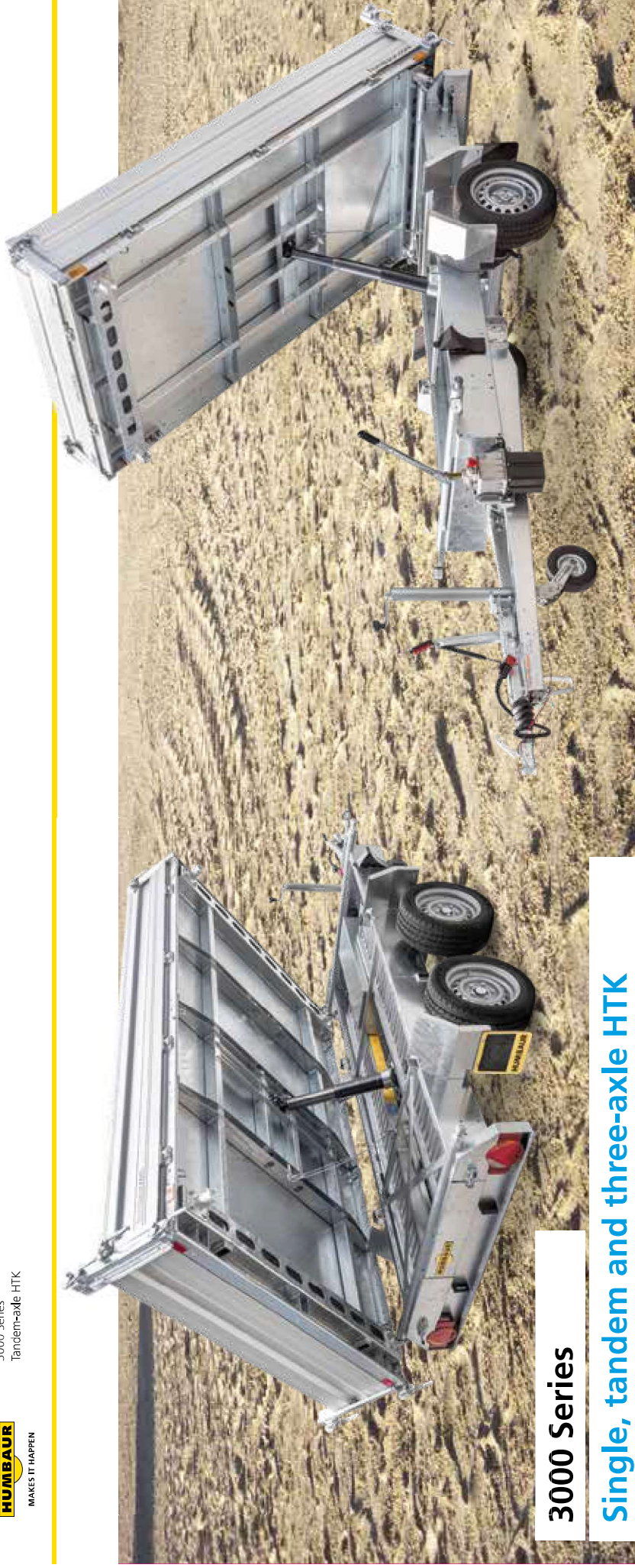

3000 Series

Single, tandem and three-axle HTK

Permissible gross weight in kg	MODEL	Overall dimension in mm	Internal dimensions in mm	Load capacity in kg	Load height in mm	Tyres in inches	Tilt angle (rear)	Tilt angle (side)
1,800	HTK 1800.27 ALU single-axle	4070 x 1680 x 1260	2670 x 1500 x 350	1100	775	13	45°	45°
2,000	HTK 2000.27 ALU	4070 x 1680 x 1260	2670 x 1500 x 350	1335	750	13	45°	45°
2,700	HTK 2700.27 ALU	4070 x 1680 x 1260	2670 x 1500 x 350	2025	725	13	45°	45°
2,700	HTK 2700.31 ALU	4500 x 1903 x 1260	3140 x 1750 x 350	1840	745	13	45°	45°
3,000	HTK 3000.31 ALU	4500 x 1903 x 1260	3140 x 1750 x 350	2,130	745	13	45°	45°
3,500	HTK 3500.31 ALU	4500 x 1903 x 1260	3140 x 1750 x 350	2600	760	13	45°	45°
3,000	HTK 3000.37 ALU	5026 x 2022 x 1251	3630 x 1855 x 350	2100	745	13	45°	45°
3,500	HTK 3500.37 ALU	5088 x 2023 x 1251	3630 x 1855 x 350	2485	760	13	45°	45°
3,500	HTK 3500.41 ALU	5470 x 2280 x 1240	4100 x 2100 x 350	2315	760	13	45°	45°
3,500	HTK 3500.41 ALU Tridem	5470 x 2280 x 1240	4100 x 2100 x 350	2360	750	13	45°	45°

Subject to change without notice. All dimensions are approximate values and refer to the standard vehicle without accessories. Additional equipment changes both the unladen weight and the load capacity!



1



2



3



4

- 1 From 3000 kg total weight electric and hand pump fitted as standard
- 2 Steel lattice extension (optional)
- 3 Recessed load-securing rings integrated in the sheet steel bridge
- 4 Standard panel bay integrated in the vehicle for easy retrofitting of the aluminium panels

Accessories (available as an option)

- Height-adjustable drawbar
- DIN towing ring for height-adjustable bar
- Ball head coupling for height-adjustable bar
- Loose wheel shock absorbers without 100 km/h confirmation
- Wheel shock absorbers mounted with 100 km/h confirmation
- Spare wheel
- Side plate extension, steel 350 mm can be pivoted
- Steel lattice extension approx. 620 mm high
- Aluminium panels with 2,8 t load-bearing capacity, 2650 mm long
- H-frame
- 2 pieces telescopic crank support incl. crossbar
- 2 additional loose tie rings (4 pieces already standard)
- Flat tarpaulins for steel lattice extension, colour of your choice
- Tarpaulin & frame, load height 1800 mm/2000 mm
- Hydraulic connection
- E-pump combined with emergency pump
- Padlock for braked trailers up to 3000 kg
- Metal locking shoe with lock for overrun hitch

Additional accessories available on request



Side panels
optionally
in steel!

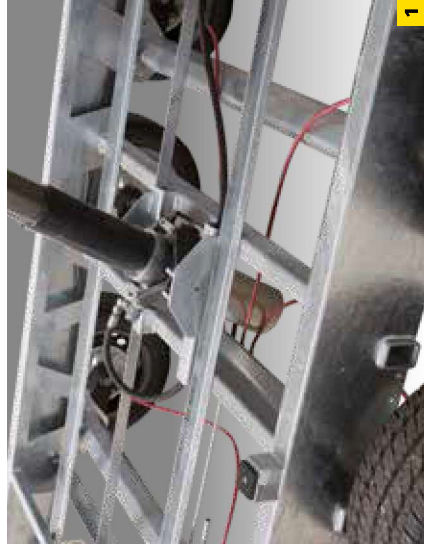

The HTK three-way tipper –
available as a tandem and
3-axle model





- 1** Solid welded frame
- 2** From 3000 kg total weight electric and hand pump fitted as standard
- 3** Telescopic crank support (optional)



Tandem-axle HS

Your plant always arrives safely



► Standard equipment

- 1** Bolted squaretow bar, hot-dip galvanised
- 2** 13-pin plug and reversing light
- 3** Welded side plate/frame construction made of sheet steel, hot-dip galvanised
- 4** Hot-dip galvanised steel ramps (1530 x 360 mm) upright, load-bearing capacity 1500 kg per ramp, with non-slip mesh lining as well as integrated supporting feet
- 5** Load-securing rings fitted x 12 in the outer frame (6 pairs) for 3000 mm and x 14 (7 pairs) for 3750 mm body length, tensile force 1000 kg for each load-securing ring
- 6** Automatic jockey wheel
- 7** Accessible sheet steel wings that lock with the side plates (standard tyres)
- 8** Humbaaur multi-function light

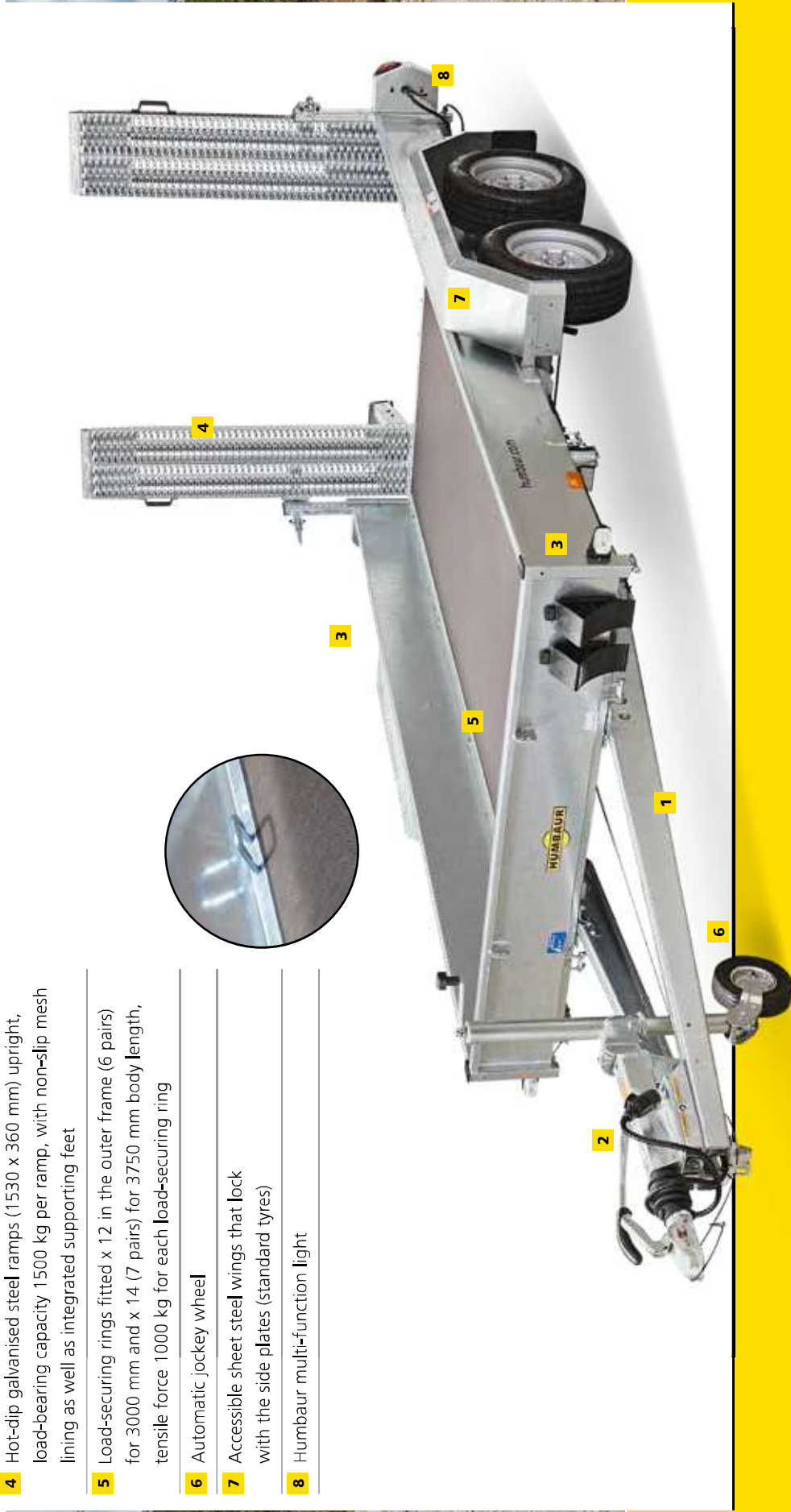



3000 Series

Tandem-axle HS

Permissible gross weight in kg	MODEL	Overall dimension in mm	Internal dimensions in mm	Load capacity in kg	Load height in mm	Tyres in inches
2,500	HS 253016	4960 x 2200 x 2015	3000 x 1600 x 270	1840	485	14
3,000	HS 303016	4960 x 2200 x 2015	3000 x 1600 x 270	2340	485	14
3,500	HS 353016	4960 x 2200 x 2020	3000 x 1600 x 270	2770	485	14
2,500	HS 253718	5710 x 2453 x 2015	3750 x 1850 x 270	1790	485	14
3,000	HS 303718	5710 x 2453 x 2015	3750 x 1850 x 270	2280	485	14
3,500	HS 353718	5710 x 2453 x 2020	3750 x 1850 x 270	2665	485	14

Subject to change without notice. All dimensions are approximate values and refer to the standard vehicle without accessories. Additional equipment changes both the unladen weight and the load capacity!

1 350 mm high aluminium slot-in partition available (optional)

2 Excavator shovel shelf for tow bar (optional)

3 Optimised, adjustable fasteners with rubber buffers



1

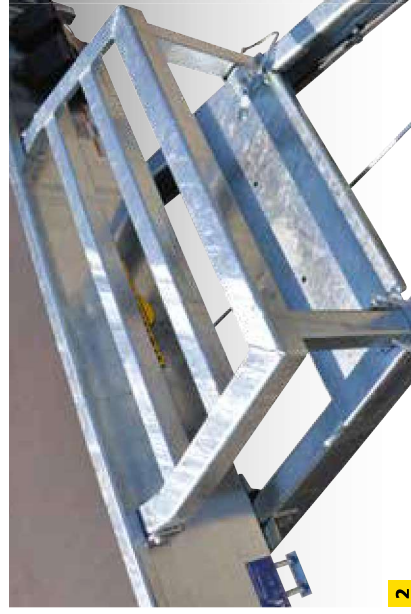

2



3

▶ **Accessories (available as an option)**

- Aluminium floor instead of wooden floor
- Aluminium slot-in partition over the entire width in front of the panel
- Folding excavator shovel shelf
- Fixed excavator shovel shelf (only possible with HV bar)
- Spare wheel holder in tow bar (not in the case of HV bar)
- Height-adjustable tow bar (without ball head coupling and DIN towing ring)
- Tarpaulin & frame, blue or grey, loading height 2000
- Wheel shock absorbers incl. 100 km/h confirmation
- Loose wheel shock absorbers
- Steel ramp panel approx. 1280 x 1870 mm high incl. support, axle load tested to 2500 kg
- Tool box approx. 515 x 212 x 292 mm
- Wheel set 12- or 13-inch instead of standard tyres optional
- Spare wheel

Additional accessories available on request



Adjustable supporting feet for different substrates



Tandem-axle HS Profi

Quick and safe loading of plant.



► Standard equipment

- 1** Welded side plate/frame construction, hot-dip galvanised
- 2** Professional cast overrun hitch with extra low hand brake lever
- 3** Aluminium ramps (1511 x 370 x 65 mm) upright, with non-slip mesh lining as well as integrated supporting feet
- 4** Railings at front, left and right are firmly welded to the frame, including 6 welded lashing points
- 5** Extra stable automatic jockey wheel
- 6** Accessible aluminium checker plate wings

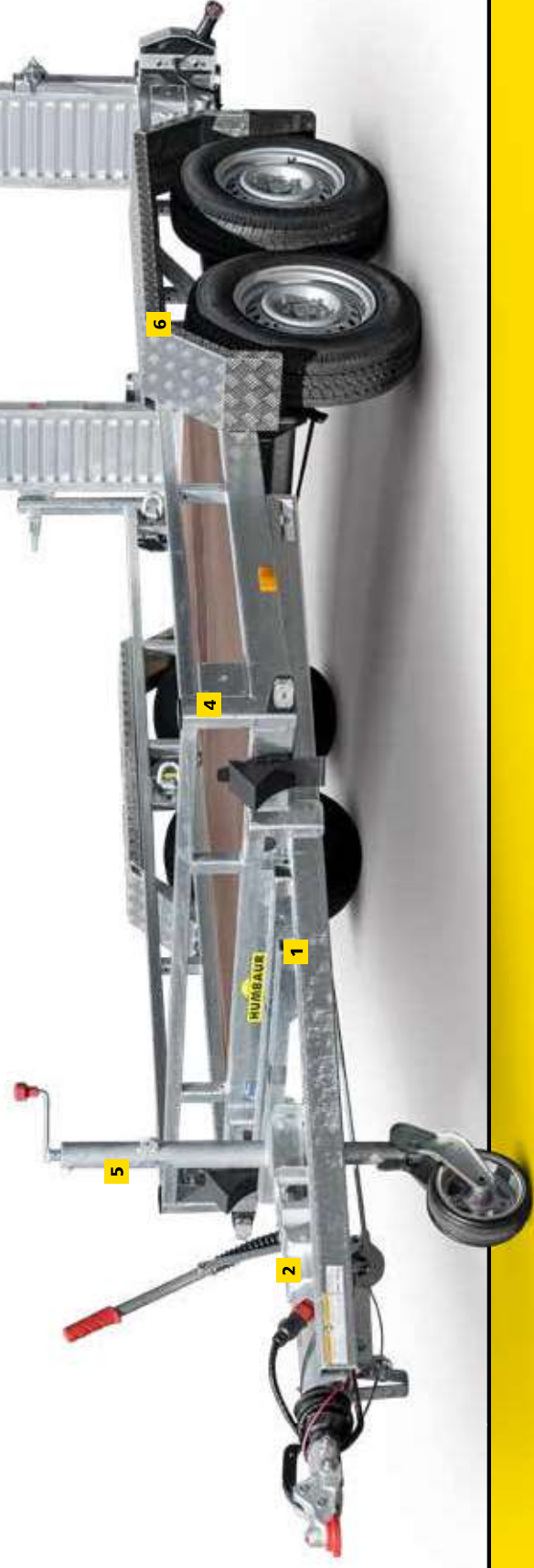



3000 Series

Tandem-axle HS

Permissible gross weight in kg	MODEL	Overall dimension in mm	Internal dimensions in mm	Load capacity in kg	Load height in mm	Tyres in inches	Ramp angle
3,500	HS 353516 Profi	5270 x 2150 x 1960	3500 x 1640 x 210	2800	450	13	13°

Subject to change without notice. All dimensions are approximate values and refer to the standard vehicle without accessories. Additional equipment changes both the unladen weight and the load capacity!

- 1 Accessible aluminium checker plate wings
- 2 Excavator shovel shelf on tow bar as standard
- 3 Optimised, adjustable fasteners with rubber buffers

► **Accessories** (available as an option)

- Aluminium side plate sheets incl. rear aluminium slot-in partition
- Wheel set 14" instead of 13"
- Spare wheel

Additional accessories available on request



Adjustable supporting feet for different substrates

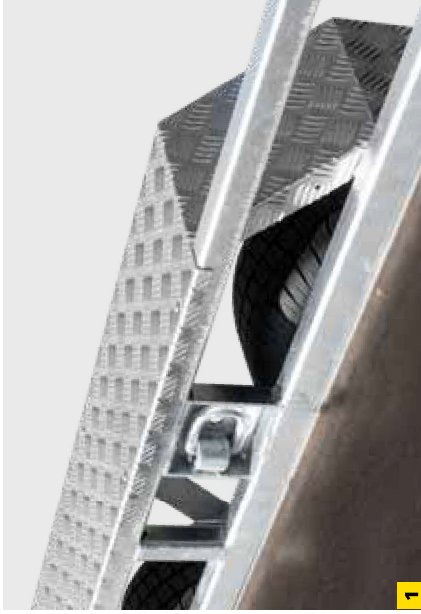

1



2



3

Optional accessories to meet your requirements

► Tyres



Spare wheel

► Body



Aluminium panels (up to 1.9 t load capacity / length 2465 mm; up to 2.3 t load-bearing capacity / length 2230 mm; up to 2.8 t load-bearing capacity / length 2650 mm)

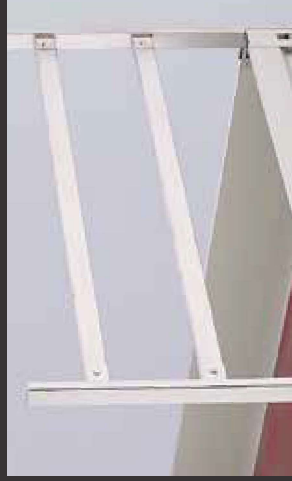

H-frame



Steel lattice extension 620 mm



Aluminium slot-in partition (in front of the panel)



Side plate extension, steel 350 mm



Excavator shovel shelf, folding for tow bar



Spare wheel bracket (loose)



Spare wheel holder (fitted)

► Chassis



Height-adjustable drawbar
(ball head coupling and DIN towing ring not included)



Ball head coupling for height-adjustable bar



DIN towing ring for height-adjustable bar



AKS safety clutch



Combined operation of hand and electric pump



Telescopic crank supports (2x)



(Loose) wheel shock absorbers without 100 km/h confirmation



Wheel shock absorbers (mounted)
incl. 100 km/h confirmation

► Anti-theft device



Padlock



Anti-theft Safety Compact



Metal locking shoe with lock

► **Securing loads**



Covering net in different sizes

► **Tarpaulins**



Flat tarpaulins in various colours and sizes

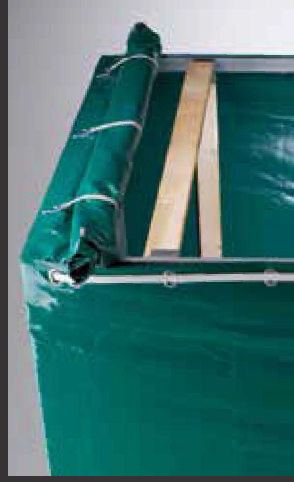

Tarpaulin & frame, load height with
1300 mm/1600 mm/1800 mm/2000 mm

Standard tarpaulin colours



White/similar to RAL 9010



Yellow/similar to RAL 1003



Orange/similar to RAL 2011



Red/similar to RAL 3002



Grey/similar to RAL 7038



Green/similar to RAL 6026



Blue/similar to RAL 5002

Please note that the colours shown may vary from the original colours.



We are happy to create customised lettering on tarpaulins upon request!

»Humbaur brand quality...«

...has been our motto since the company was established in 1957.

With around 420 series-production models for the private and commercial sectors, Humbaur is now one of Europe's leading trailer manufacturers.

Innovative and experienced, with a presence throughout Europe and beyond.

As an owner-managed, medium-sized family business, we know what our customers need and how they work. This is why we develop our products meticulously, manufacturing them with the greatest care and then putting them through their paces. Innovative ideas, cutting-edge manufacturing, a clear focus on quality and competent, comprehensive support are our strengths. Strengths that we employ to serve our customers.

*Ulrich Humbaur
Proprietor, Director/CEO*



► Take a look at our product range...

We offer a large variety of trailer models. Have a look at our brochures for our **single/tandem-axle trailers**, our **vehicle, animal and universal transporters**, **heavy-duty trailers** and **freight trailers**. We will gladly customise a trailer to meet your needs. Please contact us to discuss your requirements.



Ihr Humbaaur-Händler:

HUMBAUR

MAKES IT HAPPEN

Safety information: The trailer may only be used with experts adherence to all road traffic, professional association and load securing regulations. We assume no responsibility for printing or other errors or omissions. Subject to change without notice. All dimensions are approximate values and refer to the standard vehicle without accessories. Printed in Germany. Order No. 009.00009 - As at: 01/20. In addition, some trailers show special equipment.

